

Varenummer: 03554070

Beskrivelse: Fluro hydraulik ledhoved FMA 70D

Mål

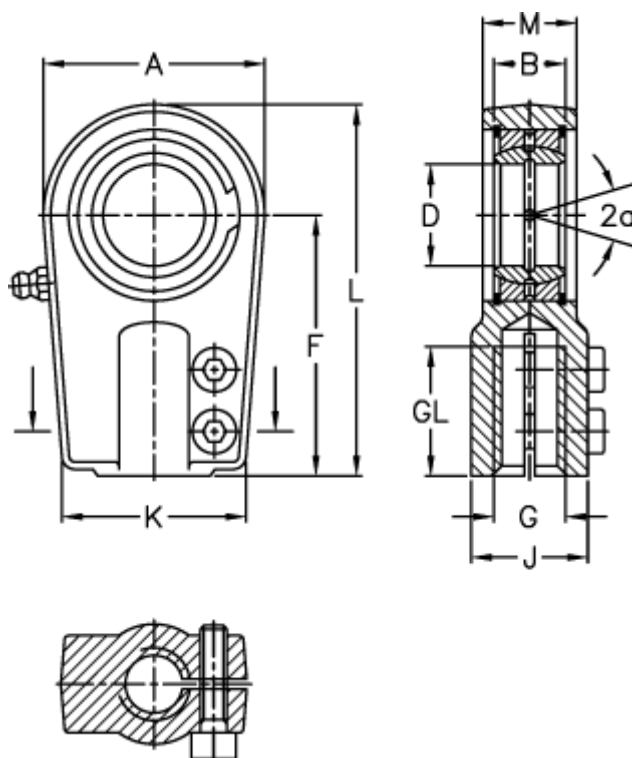

A	= 144	J	= 105
a (grader)	= 6	K	= 130
B	= 49	L	= 278
D	= 70	M	= 55
Dynamisk belastning C (kN)	= 440	Moment (Nm)	= 160
F	= 195	Statisk belastning C0 (kN)	= 721
g	= M80x3	Vægt	= 9500
GL	= 110		